

JETON[®]

ADJUSTABLE
COOLLANT HOSES

HIGH PRESSURE
ADJUSTABLE NOZZLE



JETON[®] R/D & MFG. INC.

No.17, Lane 100, Tsao-Tyi Road. Ta-Li City,
Taichung, Taiwan, R.O.C.

TEL: 886-4-24953456 FAX: 886-4-24953399

<http://www.jeton.com.tw>

E-mail: jetoninc@seed.net.tw

ISO 9001:2000

ADJUSTABLE COOLANT HOSE INTRODUCTION

Length and angle can be freely adjusted, suitable for most fluids (liquids and gases), hose orifice can be changed as needed.

Can be used for air or for water/oil supply to metal processing machinery.

- Made of Dupont 100P material; this highly rigid yet resilient acetal (POM) is strongly resistant to oils and chemicals.
- Adjustable Coolant Hose is highly pliable; it holds its shape well and will not spring back.
- Bending hose will not reduce inner diameter; hose will not pinch or fatigue.
- Adjustable Coolant Hose will not damage cutting blades if there is accidental contact.
- Adjustable Coolant Hose does not conduct electricity and is suitable for use on electrical discharge (EDM) machines.
- Four kinds of orifice inner diameter are available: 1/4", 3/8", 1/2", 3/4"
- Adjustable Coolant Hose is designed for the transport of low-pressure fluids.

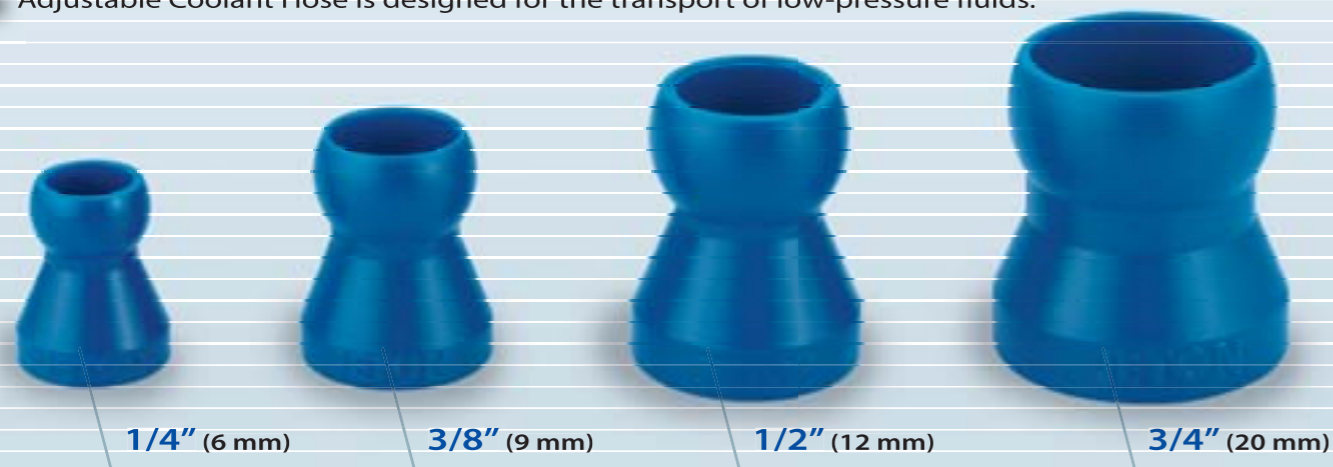

Hose Pressure and Flow Characteristics:

1/4" SYSTEM	2.0~3.0 kg/cm ²	900 Liter / hour
3/8" SYSTEM	2.0~3.0 kg/cm ²	1500 Liter / hour
1/2" SYSTEM	1.4~2.0 kg/cm ²	1700 Liter / hour
3/4" SYSTEM	0.7~1.4 kg/cm ²	1900 Liter / hour

Recommended usage:

- When using Adjustable Coolant Hose, changes in the situation may affect the maximum pressure. It is recommended that tests be performed whenever changes are made.

Thermal characteristics:

Melting point 165 °C
Maximum use temperature 65 °C

Adjustable Coolant Hose packaging

Adjustable Coolant Hose is available in cardboard boxes, bags, and coils to meet customers' specific needs.



LIST OF SUITABLE FLUIDS

Ordinary Adjustable Coolant Hoses are manufactured from acetal (POM), Hose is available in dark blue and orange colors.

ITEM	SUITABLE	UNSUITABLE
ALCOHOLS, ETHYL	○	
ACIDS		×
ACETONE	○	
BASES, STRONG		×
AMMONIUM HYDROXIDE (STRONG)		×
COMMERCIAL DISH DETERGENTS	○	
GASOLINE	○	
GREASES	○	
HYPOCHLORITE ION SOLUTIONS		×
LACQUER SOLVENTS	○	
OILS	○	
SODIUM HYDROXIDE	○	
SODIUM HYPOCHLORITE		×
INSECTICIDES	○	
BRAKE OILS	○	



LENGTH CALCULATION METHOD

Adjustable Coolant Hoses Length Calculation Method

Sample calculations



Hose Pressure and Flow Characteristics:

	Connector size (A)	+	Effective hose size (B x Number of interlocking pieces)	+	Nozzle (C)	= Total length
● 1/4"	20.9 mm	+	14.5 mm x Number of hoses	+	35.2 mm	= Total length
● 3/8"	25.0 mm	+	17.5 mm x Number of hoses	+	39.2 mm	= Total length
● 1/2"	29.8 mm	+	21.9 mm x Number of hoses	+	37.8 mm	= Total length
● 3/4"	30.3 mm	+	23.9 mm x Number of hoses	+	43.0 mm	= Total length

Installation of Adjustable Coolant Hoses

It's simple and easy to install Adjustable Coolant Hoses using the special pliers. The pliers can also be used to take apart the hose.

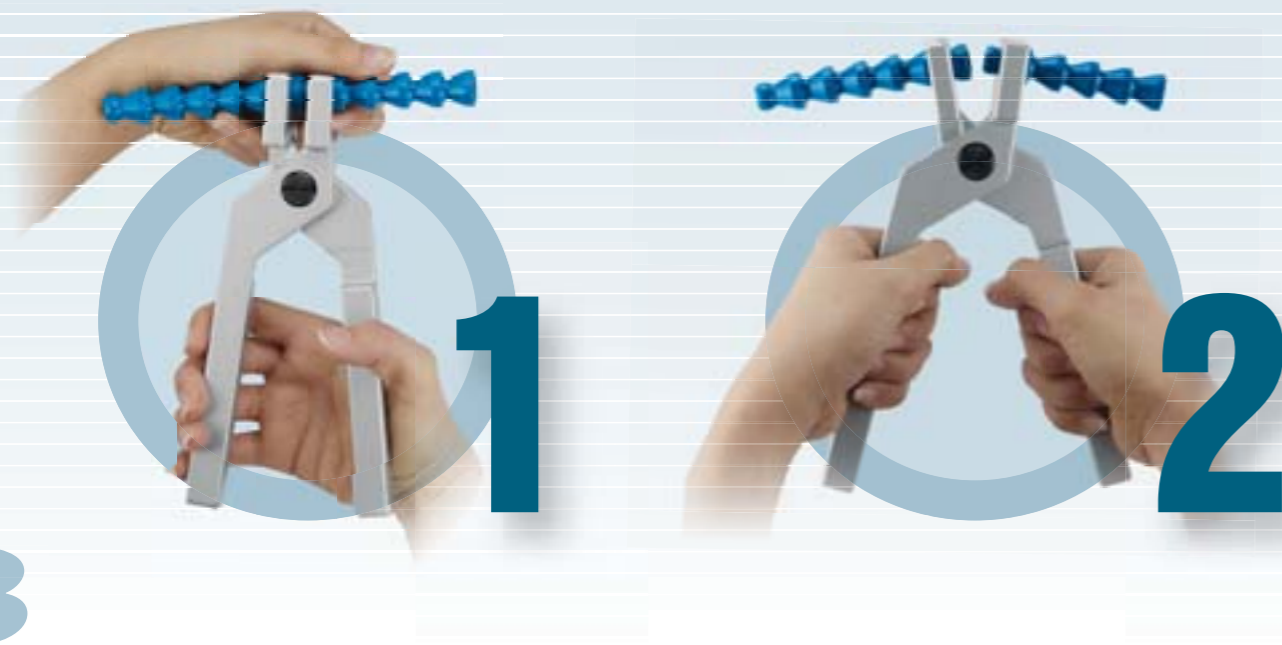

TOTAL FLOW CONTROL UNIT

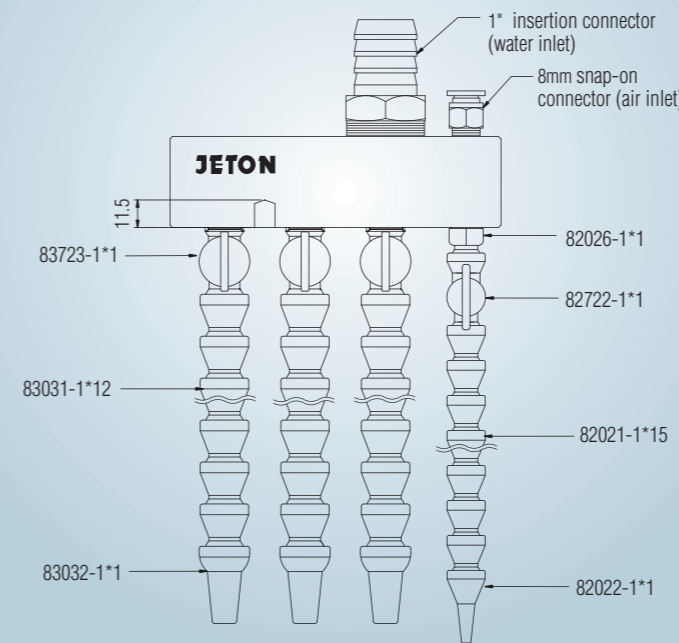
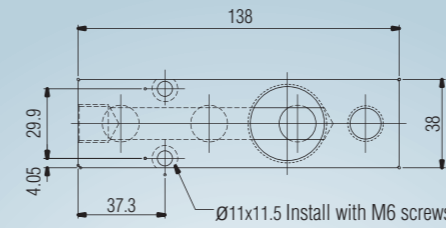

Total Flow Control Unit

The Total Flow Control Unit can be installed on all types of mechanical equipment to control of water flow. It is easy to install and makes machine more aesthetically attractive. Ensures convenient flow control.

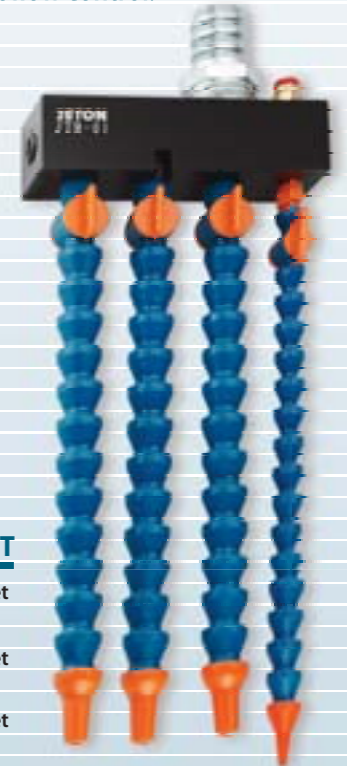

JTM-01 CONTROL UNIT

- Total Flow Control Unit 1 set
- 1/4" Adjustable Coolant Hoses & Valves Unit 1 set
- 3/8" Adjustable Coolant Hoses & Valves Unit 3 set

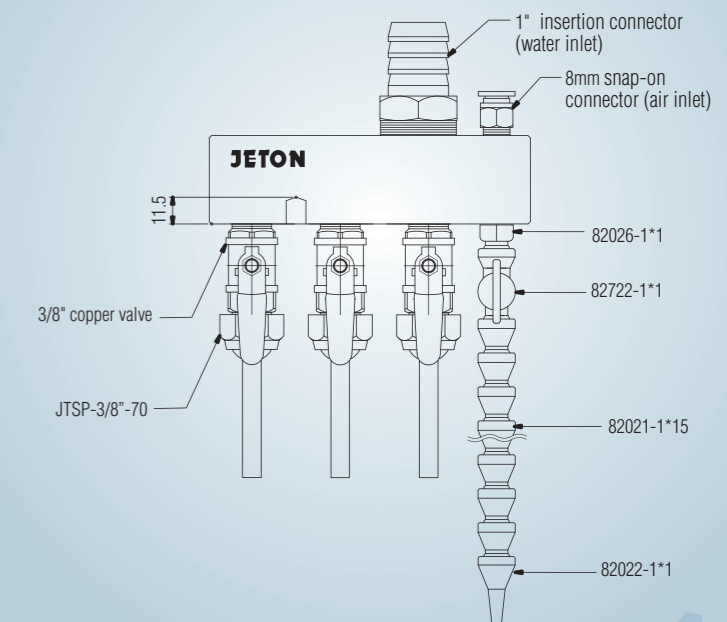
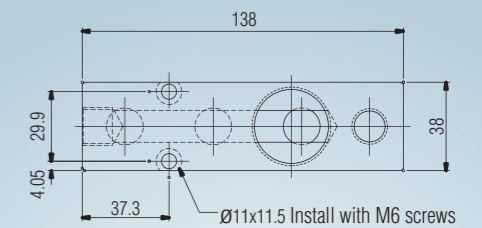

JTM-02 CONTROL UNIT

- Total Flow Control Unit 1 set
- 1/4" Adjustable Coolant Hoses & Valves Unit 1 set
- High Pressures Adjustable Nozzle 3 set



THE COLLOCATED FORM OF SYSTEM AND ACCESSORIES

1/4" SYSTEM

Male & Female Connector

82025 1/8" PT Connector	
82026 1/4" PT Connector	
82013 3/8" SAE Flare Nut Adapters	
82014 1/4" SAE Flare Nut Adapter	
82723 1/4" Male PT Valve	
82724 1/4" Female PT Valve	

Polymorphic Connector

	82028 1/4" Y Fitting
	82011 1/4" Double Socket
	82220 1/4" Extended Element Kit with Element Clamp
	62420 1/4" Elbow Fitting
	62422 1/4" Side Flow Nozzle
	62426 1/4" T Fitting
	82722 1/4" Connection Valve
	82725 1/4" Connection Check Valve

Nozzle

	82022 1/16" Round Nozzle
	82023 1/8" Round Nozzle
	82024 1/4" Round Nozzle
	82223 1/16" 90° Nozzle
	82224 1/8" 90° Nozzle
	82225 1/4" 90° Nozzle
	82226 1/4" 90° Spray Bar Nozzle
	82017 3/8" Flat Nozzle
	82027 1" Flare Nozzle
	82228 1/4" Swivel Nozzle 40
	82229 1/4" Swivel Nozzle 60
	82029 1/4" PT Connector
	82012 1/4" Socket to 1/8" NPTF
	82052 1/4" Female PT Connector
	82062 1/4" Female NPTF Connector

3/8" SYSTEM

Male & Female Connector

83035 3/8" PT Connector	
83036 1/2" PT Connector	
83026 1/4" PT to 3/8" Segment Connector	
83723 3/8" Male PT Valve	
83724 3/8" Female PT Valve	

Nozzle

	83032 1/4" Round Nozzle
	83033 3/8" Round Nozzle
	83034 1/2" Round Nozzle
	83037 1-1/4" Flare Nozzle

1/2" SYSTEM

Male & Female Connector

84045 1/2" PT Connector	
84046 3/8" PT Connector	
84013 3/8" SAE Flare Nut Adapter	
84723 1/2" Male PT Valve	
84724 1/2" Female PT Valve	

Polymorphic Connector

	84011 1/2" Double Socket
	84048 1/2" Y Fitting
	84440 1/2" Extended Element Kit with Element Clamp
	64620 1/2" Elbow Fitting
	64622 1/2" Side Flow Nozzle
	64626 1/2" T Fitting
	84722 1/2" Connection Valve
	84725 1/2" Connection Check Valve

Nozzle

	84042 3/8" Round Nozzle
	84043 1/2" Round Nozzle
	84044 1/4" Round Nozzle
	84443 1/4" 90° Nozzle
	84444 3/8" 90° Nozzle
	84445 1/2" 90° Nozzle
	84446 1/2" 90° Spray Bar
	84047 1-1/4" Flare Nozzle
	84050 1-3/4" Flare Nozzle
	84052 2-1/2" Flare Nozzle

3/4" SYSTEM

Male & Female Connector

86064 3/4" PT Connector	
-----------------------------------	--

Polymorphic Connector

















	86068 3/4" Y Fitting
	86011 3/4" Double Socket

















Nozzle

	86063 5/8" Round Nozzle
	86062 3/4" Round Nozzle
	86067 3" Flare Nozzle

















1/4" SYSTEM 1/4" INSIDE DIAMETER

ITEM NO.	DESCRIPTION
 82020	1/4" Hose Kit 10 pcs of 1/4" Segment -2 sets 1/16", 1/8", 1/4" Nozzles 1/4" & 1/8" Male PT connectors
 82020A	1/4" Hose Kit 10 pcs of 1/4" Segment -2 sets 1/16", 1/8", 1/4" Nozzles 1/4" & 1/8" Male NPT connectors
 82220	1/4" Extended Element Kit with Element Clamp Include 4 each of: 1/4" Extended Elements 1/4" Element Clamps
 82021	1/4" Segment pack (2-14 CM pcs)
 82051	1/4" 1524 CM coil
 82071	1/4" 2500 CM coil
 62423	1/4" Circle Flow Nozzle Kit Assembled with 15 Side Flow Nozzles 1/4" & 1 End Cap 1/4"
 82221	1/4" Extended Element, pack of 4
 82241	1/4" Extended Element, pack of 20
 82222	1/4" Element Clamp, pack of 4
 82242	1/4" Element Clamp, pack of 20











ITEM NO.	DESCRIPTION
 82326	1/4" 90° Nozzle Kit 1 Each: 1/16", 1/8", 1/4" & Spray Bar Nozzle
 82022	1/16" Round Nozzle, pack of 4
 82042	1/16" Round Nozzle, pack of 50
 82023	1/8" Round Nozzle, pack of 4
 82043	1/8" Round Nozzle, pack of 50
 82024	1/4" Round Nozzle, pack of 4
 82044	1/4" Round Nozzle, pack of 50
 82223	1/16" 90° Nozzle, pack of 4
 82243	1/16" 90° Nozzle, pack of 20
 82224	1/8" 90° Nozzle, pack of 4
 82244	1/8" 90° Nozzle, pack of 20
 82225	1/4" 90° Nozzle, pack of 4
 82245	1/4" 90° Nozzle, pack of 20
 82226	1/4" 90° Spray Bar Nozzle, pack of 2
 82246	1/4" 90° Spray Bar Nozzle, pack of 20
 82017	3/8" Flat Nozzle, pack of 2
 82037	3/8" Flat Nozzle, pack of 20









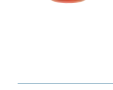

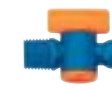
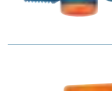
ITEM NO.	DESCRIPTION
 82027	1" Flare Nozzle, pack of 2
 82047	1" Flare Nozzle, pack of 20
 82025	1/8" PT Connector, pack of 4
 82035	1/8" PT Connector, pack of 50
 82025A	1/8" NPT Connector, pack of 4
 82035A	1/8" NPT Connector, pack of 50
 82026	1/4" PT Connector, pack of 4
 82036	1/4" PT Connector, pack of 50
 82026A	1/4" NPT Connector, pack of 4
 82036A	1/4" NPT Connector, pack of 50
 82029	1/4" PT Connector, pack of 4
 82039	1/4" PT Connector, pack of 50
 82028	1/4" Y Fitting, pack of 2
 82038	1/4" Y Fitting, pack of 20
 82011	1/4" Double Socket, pack of 4
 82031	1/4" Double Socket, pack of 20



ITEM NO.	DESCRIPTION
 82012	1/4" Socket to 1/8" NPTF, pack of 4
 82032	1/4" Socket to 1/8" NPTF, pack of 20
 82052	1/4" Female PT Connector, pack of 4
 82072	1/4" Female PT Connector, pack of 50
 82062	1/4" Female NPTF Connector, pack of 4
 82082	1/4" Female NPTF Connector, pack of 50
 82013	5/8" Female UNF Connector, pack of 4
 82033	5/8" Female UNF Connector, pack of 50
 82014	7/16" Female UNF Connector, pack of 4
 82034	7/16" Female UNF Connector, pack of 50
 62420	1/4" Elbow Fitting pack of 2
 62430	1/4" Elbow Fitting pack of 20
 62426	1/4" T Fitting Pack of 2
 62436	1/4" T Fitting Pack of 20
 62422	1/4" Side Flow Nozzle, pack of 4
 62442	1/4" Side Flow Nozzle, pack of 20







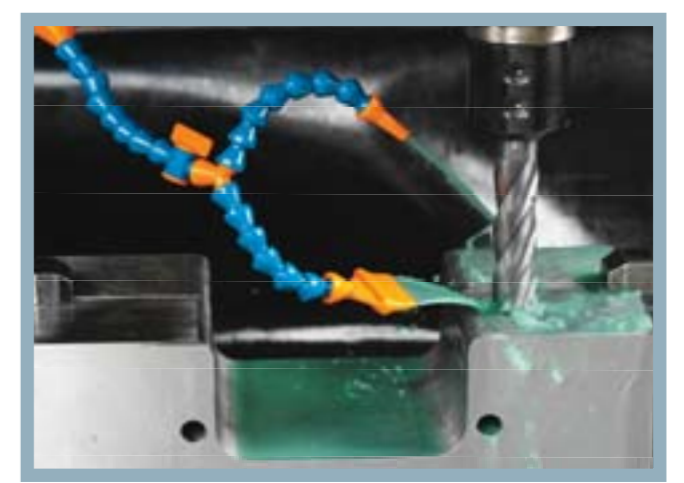



ITEM NO.	DESCRIPTION
 62424	1/4" End Cap, pack of 4
 62444	1/4" End Cap, pack of 20
 82228	1/4" Swivel Nozzle 40, pack of 2
 82248	1/4" Swivel Nozzle 40, pack of 20
 82229	1/4" Swivel Nozzle 60, pack of 2
 82249	1/4" Swivel Nozzle 60, pack of 20
 82721	1/4" NPT Male Hose Nipple Valve, pack of 2
 82731	1/4" NPT Male Hose Nipple Valve, pack of 10
 82722	1/4" Connection Valve, pack of 2
 82732	1/4" Connection Valve, pack of 10
 82723	1/4" Male PT Valve, pack of 2
 82733	1/4" Male PT Valve, pack of 10

ITEM NO.	DESCRIPTION
 82723A	1/4" Male NPT Valve, pack of 2
 82733A	1/4" Male NPT Valve, pack of 10
 82724	1/4" Female PT Valve, pack of 2
 82744	1/4" Female PT Valve, pack of 10
 82724A	1/4" Female NPT Valve, pack of 2
 82744A	1/4" Female NPT Valve, pack of 10
 82725	1/4" Connection Check Valve, pack of 2
 82745	1/4" Connection Check Valve, pack of 10
 52400	Modular Manifold System 1/4" 1/4" Elbow Fitting -1 piece 1/4" Manifold Bracket -1 piece 1/4" T Fitting -3 pcs 1/4" Mounting screw -3 pcs
 52410	1/4" Main Flow Control Manifold System 1/4" Modular Manifold -1 set 1/4" Connection Valve -5 pcs
 52416	1/4" Manifold Bracket, pack of 2
 26171	1/4" Hose Assembly pliers









3/8" SYSTEM 3/8" INSIDE DIAMETER (ID)



ITEM NO.	DESCRIPTION
 83030	3/8" Hose Kit 8 pcs of 3/8" Segment -2 sets 3/8" Nozzle 3/8" Male PT Connector
 83030A	3/8" Hose Kit 8 pcs of 3/8" Segment -2 sets 3/8" Nozzle 3/8" Male NPT Connector
 83430	3/8" Hose Kit 8 pcs of 3/8" Segment -2 pcs 1/4", 3/8", 1/2" Nozzles 3/8" & 1/2" Male PT Connectors

ITEM NO.	DESCRIPTION
 83430A	3/8" Hose Kit 8 pcs of 3/8" Segment -2 pcs 1/4", 3/8", 1/2" Nozzles 3/8" & 1/2" Male NPT Connectors
 83031	3/8" Segment pack (2-14.5 CM pcs)
 83051	3/8" 762 CM coil
 83091	3/8" 1524 CM coil
 83032	1/4" Round Nozzle, Pack of 4
 83052	1/4" Round Nozzle, Pack of 50
 83033	3/8" Round Nozzle, pack of 4
 83053	3/8" Round Nozzle, pack of 50

ITEM NO.	DESCRIPTION
 83034	1/2" Round Nozzle, pack of 4
 83054	1/2" Round Nozzle, pack of 50
 83026	1/4" PT Connector, pack of 4
 83046	1/4" PT Connector, pack of 50
 83035	3/8" PT Connector, pack of 4
 83055	3/8" PT Connector, pack of 50
 83035A	3/8" NPT Connector, pack of 4
 83055A	3/8" NPT Connector, pack of 50
 83036	1/2" PT Connector, pack of 4
 83056	1/2" PT Connector, pack of 50

ITEM NO.	DESCRIPTION
 83036A	1/2" NPT Connector, pack of 4
 83056A	1/2" NPT Connector, pack of 50
 83037	1 1/4" Flare Nozzle, pack of 2
 83057	1 1/4" Flare Nozzle, pack of 20
 83623	3/8" to 1/4" PT Valve, pack of 2
 83643	3/8" to 1/4" PT Valve, pack of 10





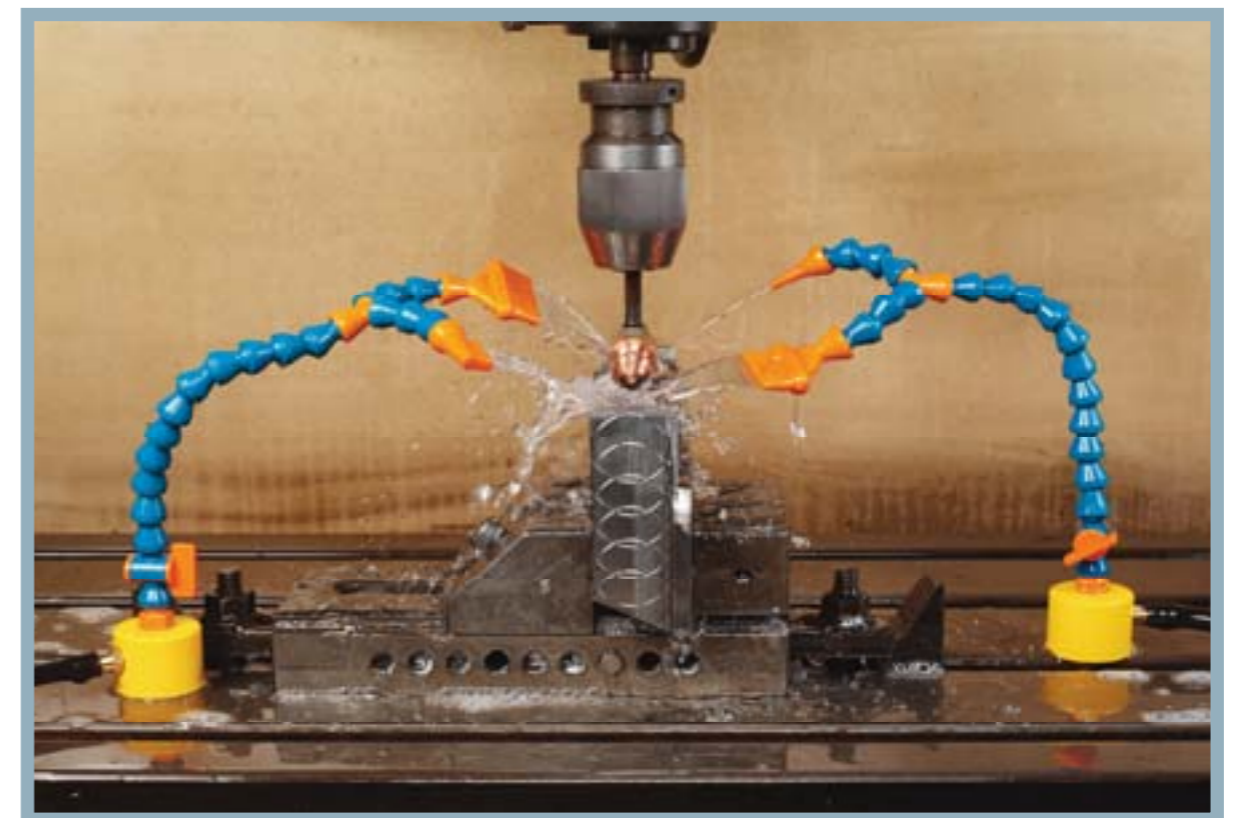







ITEM NO.	DESCRIPTION
 83723	3/8" Male PT Valve, pack of 2
 83743	3/8" Male PT Valve, pack of 10
 83723A	3/8" Male NPT Valve, pack of 2
 83743A	3/8" Male NPT Valve, pack of 10
 83724	3/8" Female PT Valve, pack of 2
 83744	3/8" Female PT Valve, pack of 10















ITEM NO.	DESCRIPTION
 83724A	3/8" Female NPT Valve, pack of 2
 83744A	3/8" Female NPT Valves, pack of 10
 26176	3/8" Hose Assembly pliers



1/2" SYSTEM 1/2" INSIDE DIAMETER

ITEM NO.	DESCRIPTION
 84040	1/2" Hose Kit 6 pcs of 1/2" Segment -2 sets 1/4", 3/8", 1/2" Nozzles 3/8", 1/2" Male PT Connectors
 84040A	1/2" Hose Kit 6 pcs of 1/2" Segment -2 sets 1/4", 3/8", 1/2" Nozzles 3/8", 1/2" Male NPT Connectors
 84440	1/2" Extended Element Kit with Element Clamp Includes 4 each of: 1/2" Extended Elements 1/2" Element Clamps
 84041	Segment pack (2-14CM pcs)
 84081	1/2" 1524CM coil
 84091	1/2" 2500CM coil
 64643	1/2" Circle Flow Nozzle Kit Assembled with 15 Side Flow Nozzles 1/2" & 1 End Cap 1/2"
 84441	1/2" Extended Element, pack of 4
 84461	1/2" Extended Element, pack of 20
 84442	1/2" Element Clamp, pack of 4
 84462	1/2" Element Clamp, pack of 20

ITEM NO.	DESCRIPTION
 84346	90° Nozzle Kit 1 Each: 1/4", 3/8", 1/2" & Spray Bar Nozzles
 84044	1/4" Round Nozzle, pack of 4
 84064	1/4" Round Nozzle, pack of 50
 84042	3/8" Round Nozzle, pack of 4
 84062	3/8" Round Nozzle, pack of 50
 84043	1/2" Round Nozzle, pack of 4
 84063	1/2" Round Nozzle, pack of 50
 84443	1/4" 90° Nozzle, pack of 4
 84463	1/4" 90° Nozzle, pack of 20
 84444	3/8" 90° Nozzle, pack of 4
 84464	3/8" 90° Nozzle, pack of 20
 84445	1/2" 90° Nozzle, pack of 4
 84465	1/2" 90° Nozzle, pack of 20







ITEM NO.	DESCRIPTION
 84446	1/2" 90° Spray Bar, pack of 2
 84466	1/2" 90° Spray Bar, pack of 20
 84047	1 1/4" Flare Nozzle, pack of 2
 84067	1 1/4" Flare Nozzle, pack of 20
 84050	1 3/4" Flare Nozzle, pack of 2
 84070	1 3/4" Flare Nozzle, pack of 20
 84052	2 1/2" Flare Nozzle, pack of 2
 84072	2 1/2" Flare Nozzle, pack of 20
 84046	3/8" PT Connector, pack of 4
 84066	3/8" PT Connector, pack of 50
 84046A	3/8" NPT Connector, pack of 4
 84066A	3/8" NPT Connector, pack of 50
 84045	1/2" PT Connector, pack of 4
 84065	1/2" PT Connector, pack of 50

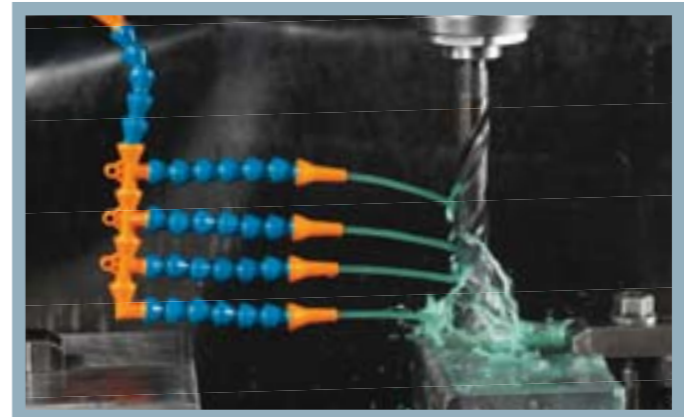

ITEM NO.	DESCRIPTION
 84045A	1/2" NPT Connector, pack of 4
 84065A	1/2" NPT Connector, pack of 50
 84048	1/2" Y Fitting, pack of 2
 84068	1/2" Y Fitting, pack of 20
 84049	1/2" to 1/4" Y Reducer, pack of 2
 84069	1/2" to 1/4" Y Reducer, pack of 20
 84651	1/2" to 1/4" Adapter, pack of 2
 84851	1/2" to 1/4" Adapter, pack of 20
 84011	1/2" Double socket, pack of 4
 84031	1/2" Double socket, pack of 20
 64620	1/2" Elbow Fitting, pack of 2
 64640	1/2" Elbow Fitting, pack of 20
 64626	1/2" T Fitting, pack of 2
 64646	1/2" T Fitting, pack of 20

ITEM NO.	DESCRIPTION
 64622	1/2" Side Flow Nozzle, pack of 4
 64642	1/2" Side Flow Nozzle, pack of 20
 64624	1/2" End cap, pack of 4
 64644	1/2" End cap, pack of 20
 84722	1/2" Connection Valve, pack of 2
 84742	1/2" Connection Valve, pack of 10
 84723	1/2" Male PT Valve, pack of 2
 84743	1/2" Male PT Valve, pack of 10
 84723A	1/2" Male NPT Valve, pack of 2
 84743A	1/2" Male NPT Valve, pack of 10
 84724	1/2" Female PT Valve, pack of 2
 84744	1/2" Female PT Valve, pack of 10
 84724A	1/2" Female NPT Valve, pack of 2
 84744A	1/2" Female NPT Valve, pack of 10

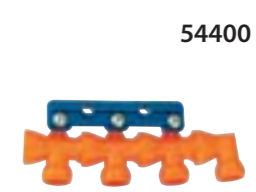
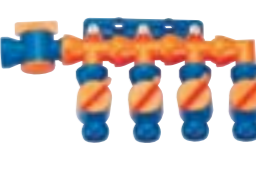

ITEM NO.	DESCRIPTION
 84725	1/2" Connection Check Valve, pack of 2
 84745	1/2" Connection Check Valve, pack of 10
 84013	3/8" SAE Flare Nut Adapter, pack of 4
 84033	3/8" SAE Flare Nut Adapter, pack of 20 (5/8-18 Thread)
 54400	Modular Manifold System 1/2" 1/2" Elbow Fitting -1 piece 1/2" Manifold Bracket -1 piece 1/2" T Fitting -3 pcs 1/2" Mounting screw -3 pcs
 54410	1/2" Main Flow Control Manifold System 1/2" Modular Manifold -1 set 1/2" Connection Valve -5 pcs
 54416	1/2" Manifold Bracket, pack of 2
 26172	1/2" Hose Assembly pliers

3/4" SYSTEM 3/4" INSIDE DIAMETER

ACID RESISTANT HOSE SYSTEM

ITEM NO.	DESCRIPTION
 86060	3/4" Hose Kit 6 pcs of 3/4" Segment -2 sets 5/8" & 3/4" Nozzles 3/4" Male PT Connector
 86060A	3/4" Hose Kit 6 pcs of 3/4" Segment -2 sets 5/8" & 3/4" Nozzles 3/4" Male NPT Connector
 86061	3/4" Segment pack (2-14.5CM pcs)
 86081	3/4" 1524cm coil
 86091	3/4" 2500cm coil

ITEM NO.	DESCRIPTION
 86063	5/8" Round Nozzle, pack of 4
 86062	3/4" Round Nozzle, pack of 4
 86064	3/4" PT Connector, pack of 4
 86064A	3/4" NPT Connector, pack of 4
 86067	3" Flare Nozzle, pack of 2
 86073	5/8" Round Nozzle, pack of 50
 86072	3/4" Round Nozzle, pack of 50
 86074	3/4" PT Connector, pack of 50
 86074A	3/4" NPT Connector, pack of 50
 86077	3" Flare Nozzle, pack of 20

ITEM NO.	DESCRIPTION
 86068	3/4" Y Fitting, pack of 2
 86051	3/4" to 1/2" Adapter, pack of 2
 86069	3/4" to 1/2" Y Reducer, pack of 2
 86011	3/4" Double Socket, pack of 4
 86031	3/4" Double Socket, pack of 20
 86078	3/4" Y Fitting, pack of 20
 86079	3/4" to 1/2" Y Reducer, pack of 20
 26177	3/4" Hose Assembly pliers

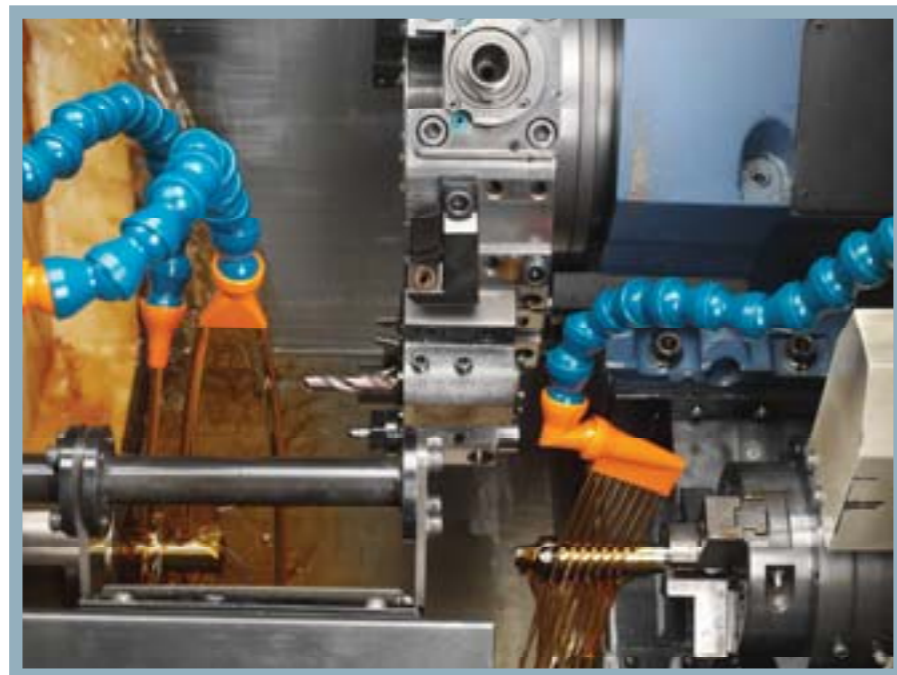

ITEM NO.	DESCRIPTION
1/4" Acid Resistant Segment Pack	
52021	14 cm 2 pcs
52051	1524 cm 1 coil
52071	2500 cm 1 coil
1/16" Acid Resistant Round Nozzle	
52022	pack of 4
52042	pack of 50
1/8" Acid Resistant Segment Pack	
52023	pack of 4
52043	pack of 50
1/4" Acid Resistant Segment Pack	
52024	pack of 4
52044	pack of 50
3/8" Acid Resistant Flar Nozzle	
52017	pack of 2
52037	pack of 20
1" Acid Resistant Flar Nozzle	
52027	pack of 2
52047	pack of 20
1/8" Acid Resistant PT Connector	
52025	pack of 4
52035	pack of 50
1/8" Acid Resistant PT Connector	
52025A	pack of 4
52035A	pack of 50
1/4" Acid Resistant PT Connector	
52026	pack of 4
52036	pack of 50
1/4" Acid Resistant PT Connector	
52026A	pack of 4
52036A	pack of 50
1/4" Acid Resistant PT Connector	
52029	pack of 4
52039	pack of 50
1/4" Acid Resistant Y Fitting	
52028	pack of 4
52038	pack of 50
1/4" Acid Resistant Double Socket	
52011	pack of 4
52031	pack of 20
1/4" Acid Resistant Elbow Fitting	
52420	pack of 2
52430	pack of 20
1/4" Acid Resistant T Fitting	
52426	pack of 2
52436	pack of 20

ITEM NO.	DESCRIPTION
3/8" Acid Resistant Segment Pack	
53031	14.5 cm 2 pcs
53051	762 cm 1 coil
53091	1524 cm 1 coil
1/4" Acid Resistant Round Nozzle	
53032	pack of 4
53052	pack of 50
3/8" Acid Resistant Round Nozzle	
53033	pack of 4
53053	pack of 50
1/2" Acid Resistant Round Nozzle	
53034	pack of 4
53054	pack of 50
1/4" Acid Resistant Round Nozzle	
53026	pack of 4
53046	pack of 50
3/8" Acid Resistant PT Connector	
53035	pack of 4
53055	pack of 50
3/8" Acid Resistant NPT Connector	
53035A	pack of 4
53055A	pack of 50
1/2" Acid Resistant PT Connector	
53036	pack of 4
53056	pack of 50
1/2" Acid Resistant NPT Connector	
53036A	pack of 4
53056A	pack of 50
1-1/4" Acid Resistant Flar Nozzle	
53037	pack of 2
53057	pack of 20

ITEM NO.	DESCRIPTION
1/2" Acid Resistant Segment Pack	
54041	14 cm 2 pcs
54081	1524 cm 1 coil
54091	2500 cm 1 coil
1/4" Acid Resistant Round Nozzle	
54044	pack of 4
54064	pack of 50
3/8" Acid Resistant Round Nozzle	
54042	pack of 4
54062	pack of 50
1/2" Acid Resistant Round Nozzle	
54043	pack of 4
54063	pack of 50
1-1/4" Acid Resistant Flar Nozzle	
54047	pack of 2
54067	pack of 20
1-3/4" Acid Resistant Flar Nozzle	
54050	pack of 2
54070	pack of 20
2-1/2" Acid Resistant Flar adNozzle	
54052	pack of 2
54072	pack of 20
3/8" Acid Resistant PT Connector	
54046	pack of 4
54066	pack of 50
3/8" Acid Resistant NPT Connector	
54046A	pack of 4
54066A	pack of 50
1/2" Acid Resistant PT Connector	
54045	pack of 4
54065	pack of 50
1/2" Acid Resistant NPT Connector	
54045A	pack of 4
54065A	pack of 50
1/2" Acid Resistant Y Fitting	
54048	pack of 2
54068	pack of 20
1/2" to 1/4" Acid Resistant Y Fitting	
54049	pack of 2
54069	pack of 20
1/2" to 1/4" Acid Resistant adapter	
54651	pack of 2
54851	pack of 20
1/2" Acid Resistant Double Socket	
54011	pack of 4
54031	pack of 20
1/2" Acid Resistant Elbow Fitting	
54620	pack of 2
54640	pack of 20
1/2" Acid Resistant T Fitting	
54626	pack of 2
54646	pack of 20

LIST OF SUITABLE FLUIDS		
Acid Resistant Adjustable Coolant Hoses are Manufactured from Polyethylenetereohthalate Hose is Available in Gray Color		
ITEM	SUITABLE	UNSUITABLE
ALCOHOLS, ETHYL	○	
ACIDS, (LESS THAN 65° C)	○	
ACIDS, (GREATER THAN 65° C)		X
ACETONE		X
AROMATIC SOLVENTS		X
CHLORINATED HYDROCARBON		X
ETHYL ACETATE		X
BASES, STRONG		X
GASOLINE	○	
GREASES	○	
HYDROCARBONS	○	
OILS	○	
SALT SOLUTIONS	○	
WATER (GREATER THAN 65° C)		X

MAGNETIC BASE - SHIELD BOARD SYSTEM

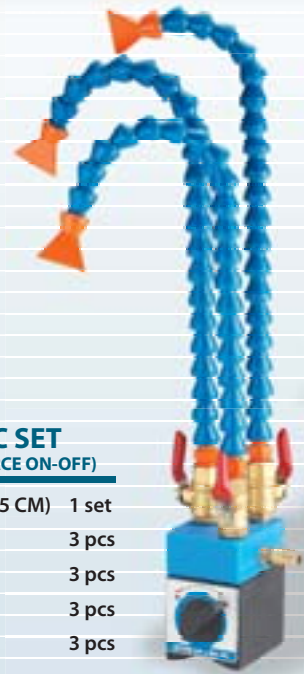

87011 MAGNETIC SET (MAGNETIC FORCE ON-OFF)

- Magnetic Base (W5xL6.5xH5 CM) 1 set
- 20 pcs of 1/4" Segment 3 pcs
- 1" Flare Nozzle 3 pcs
- 1/4" PT Connector 3 pcs
- 1/4" Copper Valve 3 pcs



87002 MAGNETIC SET (MAGNETIC FORCE ON-OFF)

- Magnetic Base (W5xL6.5xH5 CM) 1 set
- 20 pcs of 1/4" Segment 2 pcs
- 1" Flare Nozzle 2 pcs
- 1/4" PT Connector 2 pcs
- 1/4" Copper Valve 2 pcs

SHIELD KIT 34101 (6" X 8")

34102 (7-1/2" X 10")

34103 (8-1/2" X 12")

- Magnetic Base 1 set
- 12 pcs of 3/4" Segment 1 piece
- 3/4" Shield Mounting Elbows 1 piece
- 3/4" Fixed Mounts 1 piece
- Nut 2 pcs
- Acrylic Board 1 piece

88003 MAGNETIC SET

- Magnetic Base 1 set
- 10 pcs of 1/4" Segment 1 piece
- 1" Flare Nozzle 1 piece
- 1/4" PT Connector 1 piece

88005 MAGNETIC SET

- Magnetic Base 1 set
- 10 pcs of 1/4" Segment 1 piece
- 1" Flare Nozzle 1 piece
- 1/4" Male PT Valves 1 piece

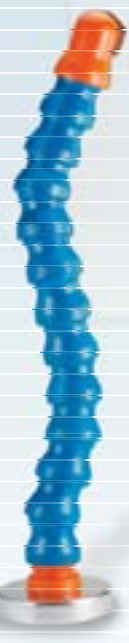
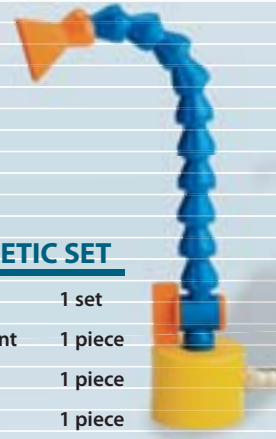
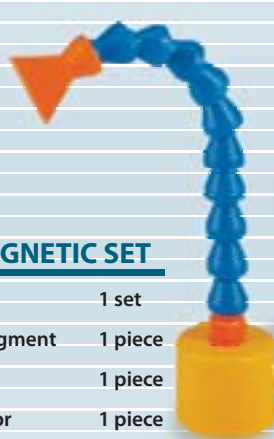

88103 MAGNETIC SET

- Magnetic Base 1 set
- 20 pcs of 1/4" Segment 1 piece
- 1" Flare Nozzle 1 piece
- 1/4" PT Connector 1 piece

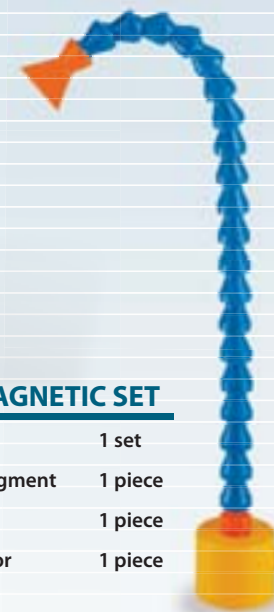

88105 MAGNETIC SET

- Magnetic Base 1 set
- 20 pcs of 1/4" Segment 1 piece
- 1" Flare Nozzle 1 piece
- 1/4" Male PT Valves 1 piece

ADJUSTABLE COOLANT HOSES & VALVES

1/4" 62720 33CM Length Hose Kit

- 1/4" Male PT or NPT Valve, 1 piece
- 20 pcs of 1/4" Segment 1 piece
- 1/16", 1/8" or 1/4" Round Nozzle 1 piece



62721 33CM Length Hose Kit

- 1/4" Female PT or NPT Valve, 1 piece
- 20 pcs of 1/4" Segment 1 piece
- 1/16", 1/8" or 1/4" Round Nozzle 1 piece



3/8" 63720 36CM Length Hose Kit

- 3/8" Male PT or NPT Valve, 1 piece
- 16 pcs of 3/8" Segment 1 piece
- 1/4", 3/8" or 1/2" Round Nozzle 1 piece



63721 36CM Length Hose Kit

- 3/8" Female PT or NPT Valve, 1 piece
- 16 pcs of 3/8" Segment 1 piece
- 1/4", 3/8" or 1/2" Round Nozzle 1 piece



1/2" 64720 33CM Length Hose Kit

- 1/2" Male PT or NPT Valve, 1 piece
- 12 pcs of 1/2" Segment 1 piece
- 1/4", 3/8" or 1/2" Round Nozzle 1 piece

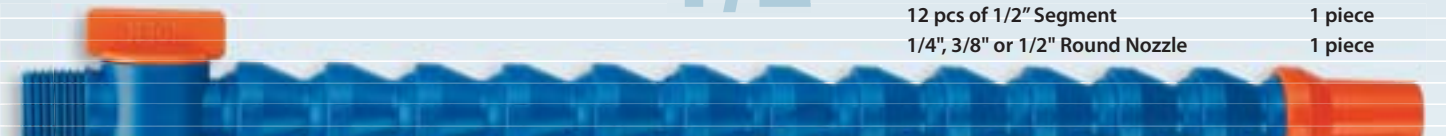

64721 33CM Length Hose Kit

- 1/2" Female PT or NPT Valve, 1 piece
- 12 pcs of 1/2" Segment 1 piece
- 1/4", 3/8" or 1/2" Round Nozzle 1 piece



SYSTEM & SPECIFICATION

1/4" SYSTEM & SPECIFICATION

82021+82021	82013	82022	82722	82226	62426
82025	82014	82023	82723	62423	
82026	82028	82024	82724	52416	
82029	82011	82223	82224	82228	
82012	62420	82725	82225	82229	
82052	82027	82017	82220		

3/8" SYSTEM & SPECIFICATION 1/2" SYSTEM & SPECIFICATION

83031+83031	83037	83723
83035	83032	83724
83036	83033	83034
84043	84443	84723
84044	84445	84724

1/2" SYSTEM & SPECIFICATION

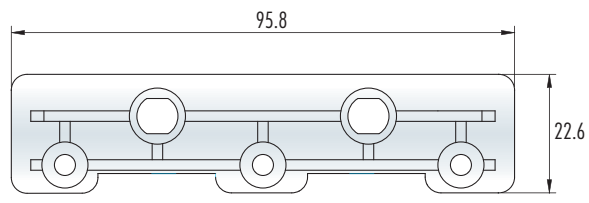
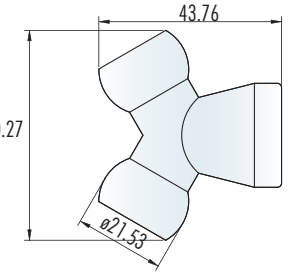
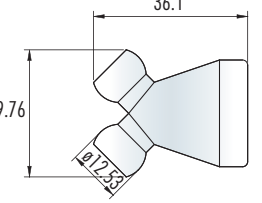
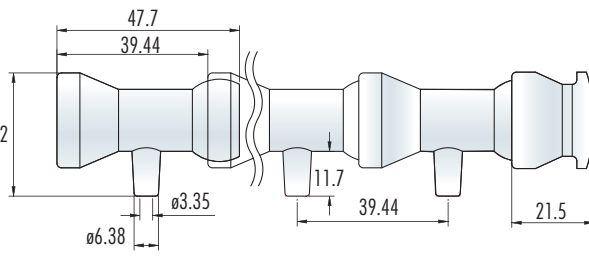
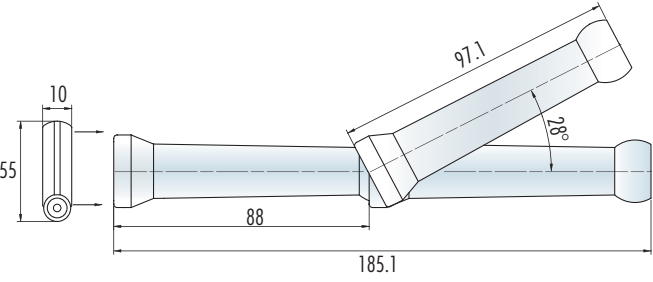
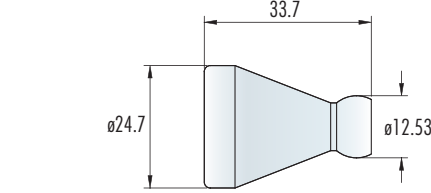
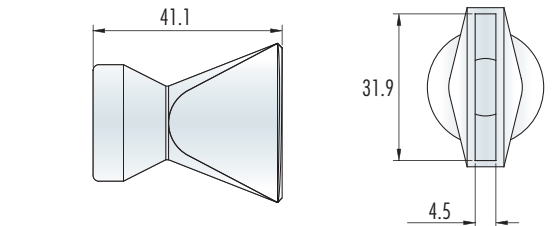
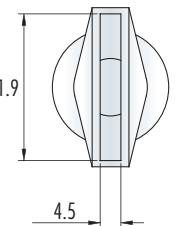
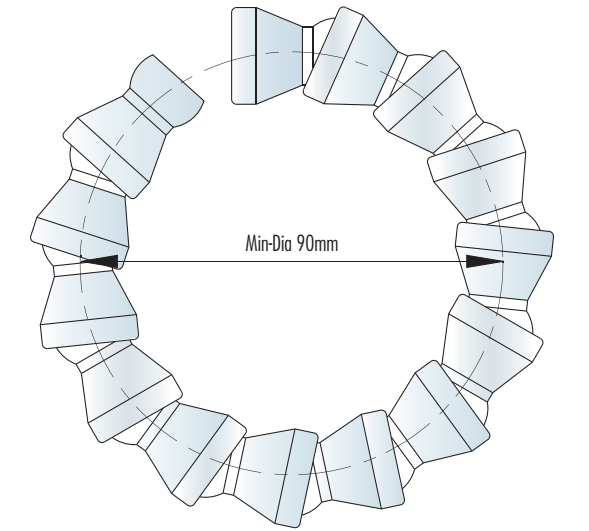
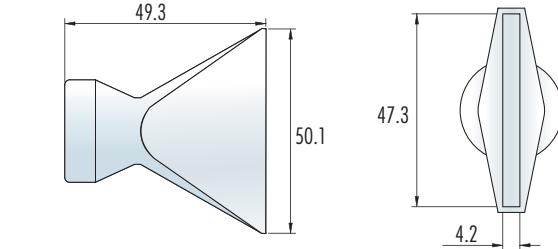
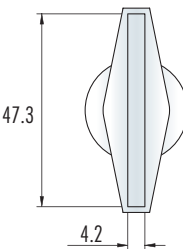
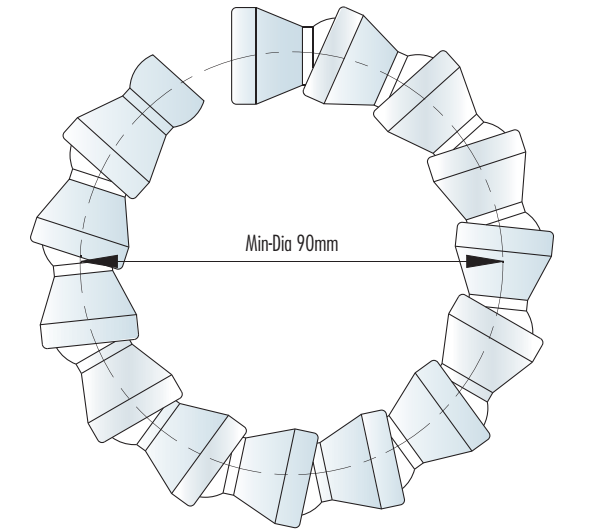
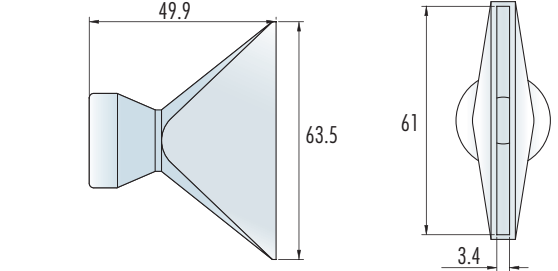
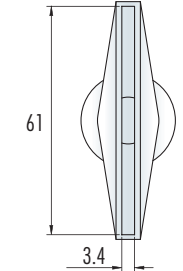
		
54416	84048	84049
		
64643	84440	
		
84651	84047	84047
		
84052	84050	84050
		
84052	84052	84052

3/4" SYSTEM & SPECIFICATION

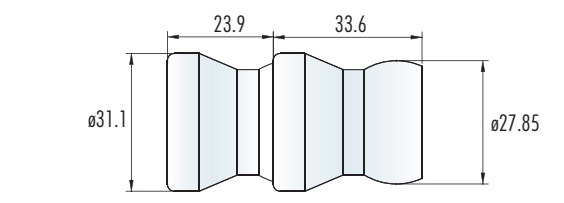
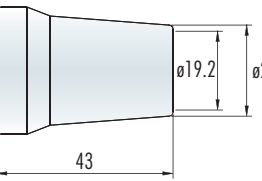
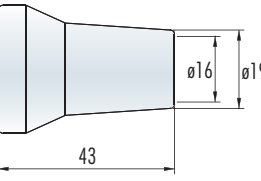
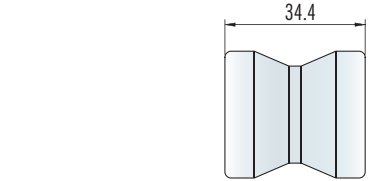
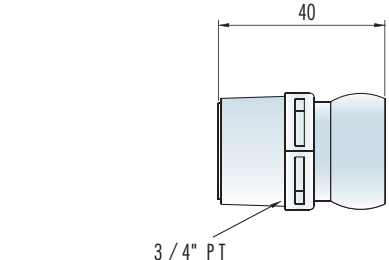
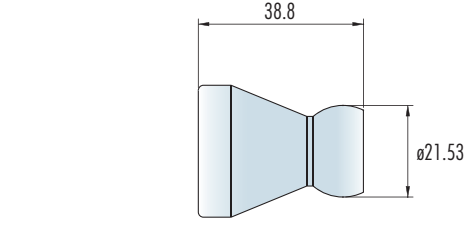
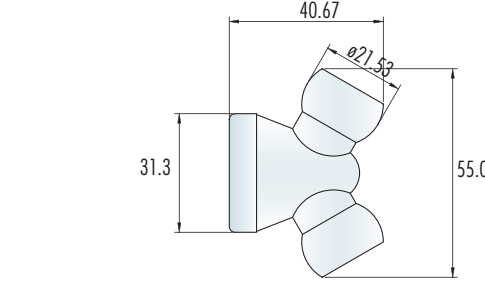
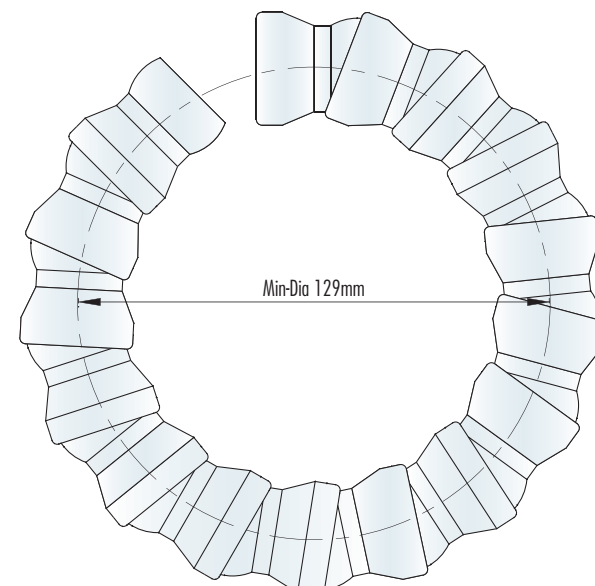
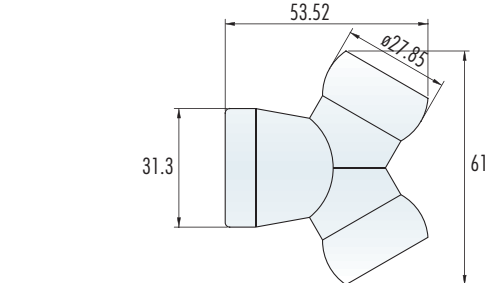
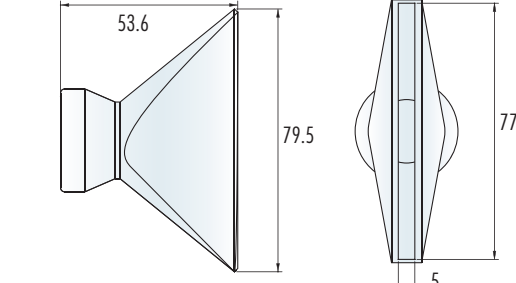
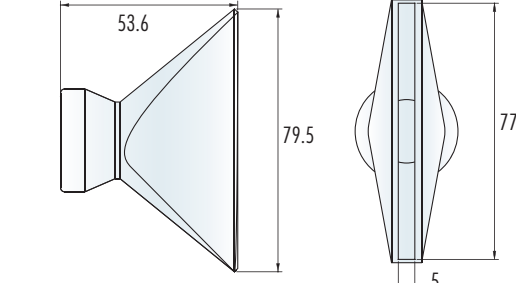
		
86061+86061	86062	86063
		
86011	86064	
		
86051	86069	
		
86067	86068	
		
86067	86067	